



≡ Complete
Gastronorm
Refrigeration



Confidence in your kitchen

The True difference: an extensive range of best-in-class products, with solutions for every kitchen.

True products are aimed at energy and environment conscious operators who are serious about food safety and quality, and understand that refrigeration equipment is a core investment of their business. This brochure highlights a range of True products specifically designed to accept varying sizes of Gastronorm pans, either featuring internal pan slide systems or drawers which accept various pan arrangements.

A great many other True products will accept varying sizes of GN pans sat on internal shelving, but these have not been included in the selection presented here. To discuss any detail of True's product range, including internal dimensions or net capacities, please contact our Sales and Customer Service teams.

SUSTAINABILITY

Our Natural Refrigerant initiative aligns perfectly with operators focused on responsible environmental practices. True "HC" products provide comparatively quicker temperature recovery and significantly reduce energy consumption.

TEMPERATURE

We are world leaders in commercial refrigeration built on a reputation that every True product must be able to maintain consistent, accurate and safe storage temperatures, even in the most demanding of foodservice environments.

SUPPORT

ALL True products are covered, as standard, by an industry-leading 5 Years Parts & Labour Warranty. We provide premier customer service and after-sale support to our clients locally, for guaranteed peace of mind.

ENERGY EFFICIENCY

Today, every serious operator has targets around sustainability, including energy management programmes to reduce wastage. By choosing the latest, most efficient equipment available, energy consumption can be considerably reduced.

Counter & Undercounters

TCR/F
p.6



TUC
p.8



Upright Cabinets

TGN
p.10



Refrigerated Equipment Stand

TRCB
p.12



Prep Counters

TPP
p.14



TSSU
p.16



Using Gastronorm

Gastronorm is a food container sizing standard used throughout the catering and hospitality industry.

A full-size Gastronorm container is referred to as “**1/1**” and measures 530mm x 325mm. All other sizes are fractions or multiples of this size.

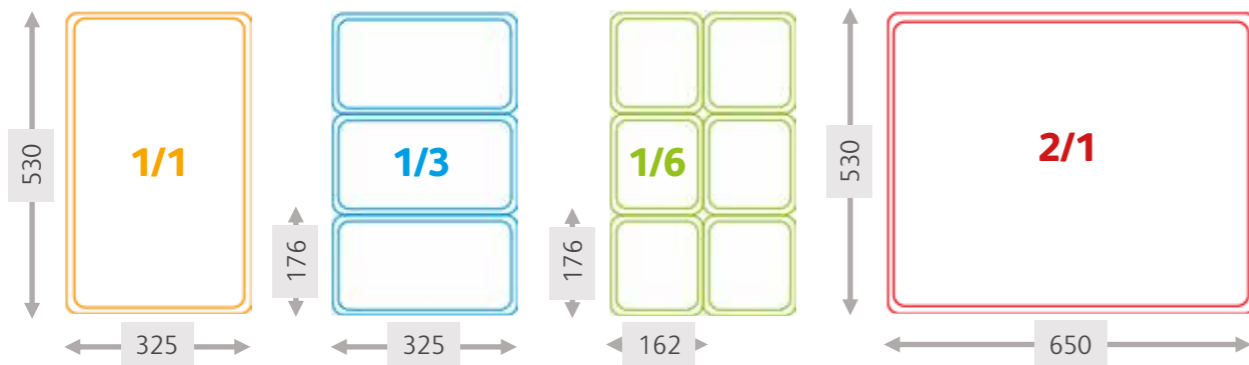

A **1/3** container is 325mm (same as 1/1) but just a third as wide (176mm), while a **1/6** is half the size again. **2/1** is twice the size of **1/1**, measuring 530mm x 650mm.

These are the most common sizes, but there are many more fractional pan sizes in the complete system.

Pans also have different depths, incl. 100mm, 150mm and 200mm.

2/1
1/1
1/3
1/6

A quick compatibility reference for each product can be found on each page.



Configure pans to your operation



A big advantage of Gastronorm is being able to mix pan sizes in the space available to match your menu.

A pizza operator might choose a **1/1** pan for cheese, **1/3** pans for common toppings, and **1/6** size pans for premium or less popular ingredients.



Achieving mixed pan arrangements on True equipment is accomplished using 'divider bars' which sit across the pan space to ensure that each container is properly supported.

Different pan arrangements may require different sizes and quantities of divider bars, so we recommend talking to us directly about your requirement.



True Gastronorm products support a wide range of third-party manufacturer pans, such as Cambro and Rubbermaid. Despite the standard sizes specified by Gastronorm, there can still be some variation between containers from different manufacturers (usually the pan "lip" or "shoulder") which can result in pans not fitting properly. In these situations, a different width of divider bar may be required. Any gaps between pans can severely impact the operating efficiency of the refrigeration system.



1/1 GN Counter units **TCR/TCF**

System Section

Can be situated left or right.

Door Section

Door hinging can be specified left or right
2x dual tray slides + 2x wire shelves accommodate 4x 1/1 pan (max depth 100 mm)

2 Drawer Section

Each drawer accommodates 1x 1/1 pan (max depth 150 mm)

3 Drawer Section

Top drawer accommodates 1x 1/1 pan (max depth 75 mm)
Middle & Lower drawers accommodate 1x 1/1 pan (max depth 100 mm)



SPECIFICATION & OPTIONS

- 2 and 3 section counters
- Fridge or freezer models
- Doors standard
- 2 or 3 drawer sections (Refrigerator only)
- Refrigerators maintain holding temperatures of 0.5°C to 3.3°C
- Refrigeration system left or right
- Biscuit top (Unit height 840mm)
- 100mm backslash option
- RCU Reverse Fan Motor
- Freezers maintain holding temperatures of -18°C to -21°C



Height options

Counter top = 900 mm high

Worktop = 1000 mm high

Biscuit Top = 840 mm high



Sections	2	3
Product	TCR1/2	TCR1/3
Dimensions LxD	1411 x 700	1865 x 700

Depth does not include 41mm for door/drawer handles.

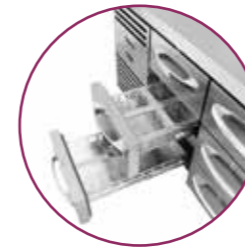

As standard, TCR Counter door sections are supplied with 2x dual tray slides + 2x wire shelves.

Drawer sections are supplied with 1 vertical divider bar per drawer, facilitating 6x 1/6 size pans. Maximum pan depth varies by drawer.

GN pans sold separately.

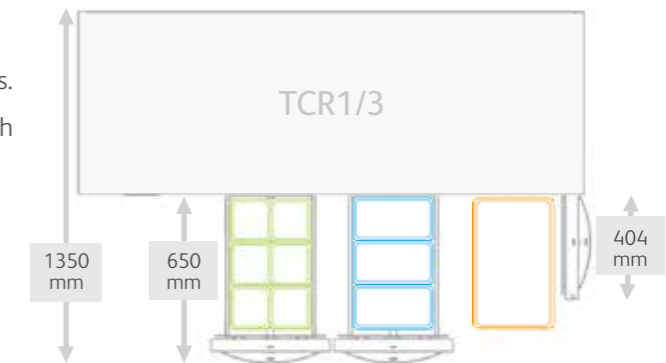

1/1

1/3

1/6

Build your own

Our counters are highly customisable to fit your operation and application. All together, there are 552 different model permutations to choose from. To make it easier, we have created a straightforward configuration tool available at:



www.truerefrigeration.co.uk/counter-config/



Undercounters TUC



SPECIFICATION & OPTIONS

- Refrigerator or Freezer models
- Glass doors (refrigerator)
- Drawer options (including freezer model)
- All stainless “Spec” upgrade available
- Available with a “splash back” (TWT models)
- Refrigerators maintain holding temperatures of 0.5°C to 3.3°C
- “Deep” Undercounter models available, featuring side-mounted systems for additional net capacity
- Reduced height castor option
- Reverse Fan Motor on most models
- Freezers maintain holding temperatures of -23°C



Sections	1	2	3	
Product	TUC-27D-2	TUC-60D-4	TUC-67D-4	TUC-93D-6
Dimensions LxDxH	702 x 766 x 839	1534 x 766 x 839	1709 x 818 x 839	2373 x 818 x 839
Drawers	2	4	4	6
Maximum capacity per drawer	1x 1/1 GN (150mm deep)	1x 1/1 GN (150mm deep)	1x 2/1 GN (200mm deep)	1x 2/1 GN (200mm deep)

Depth do not include 26 mm for rear bumpers.

True's Undercounter products come in two different types, each accepting a different arrangement of GN pans.

Slim GN Undercounters

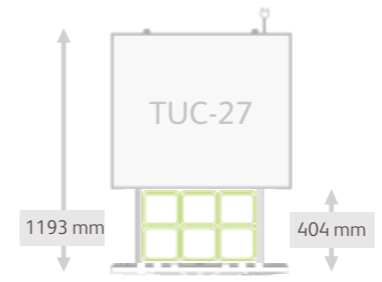

TUC 27 & 60 feature internally integrated refrigeration systems, accepting 1x 1/1 pan per drawer, ideal for operations where space is limited.

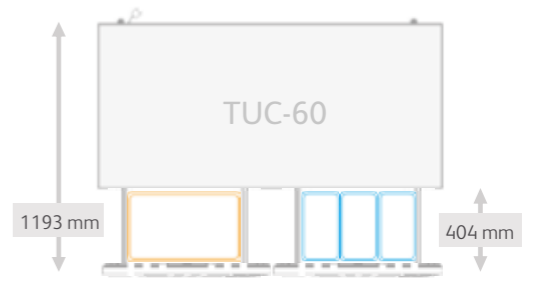

TUC 27 & 60 products accept 1x 1/1 or 3x 1/3 pans per drawer. To accommodate 1/6 size pans and other combination arrangements, divider bars (sold separately) will be required.

Deep GN Undercounters

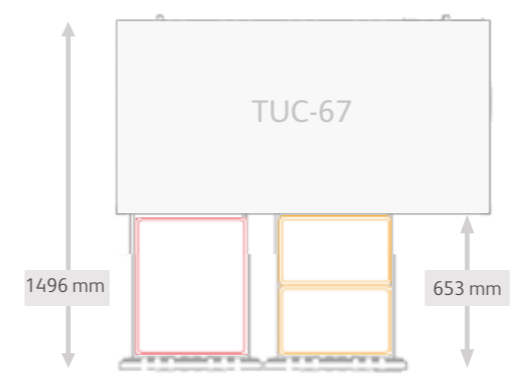

TUC 67 & 93 products feature a side-mounted system, benefitting from deeper capacity, accepting 1x 2/1 pan per drawer. These units are wider as a result.

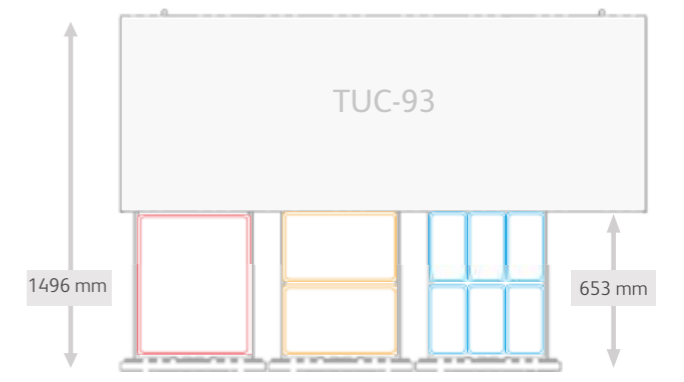

Deep TUC 67 & 93 products are supplied with 1 horizontal divider bar per drawer, facilitating 2x 1/1 pans, 6x 1/3 pans, or a combination of. To accommodate 1/6 size pans and other combination arrangements, further divider bars will be required.



2/1 GN Upright Cabinets TGN



Door locks as standard.

Digital control for state of the art temperature precision.
Environmentally friendly R290 hydrocarbon refrigeration system for the best in food preservation.

natural refrigerant.

Dual tray slide system with anti-tilt for wire shelves & 2/1 GN pan storage.

Sleek, heavy duty metal handles.

Field reversible door hinge.

Compressors perform better in the coolest, most grease free area of the kitchen.

Sections	1	2
Product	TGN-1	TGN-2
Dimensions LxDxH	729 x 858 x 2079	1460 X 858 X 2079
Net Capacity (Ltrs)	435	883
Maximum pan size	2/1 GN	2/1 GN

Depth does not include 46 mm for door handle or 13 mm for rear access grill.

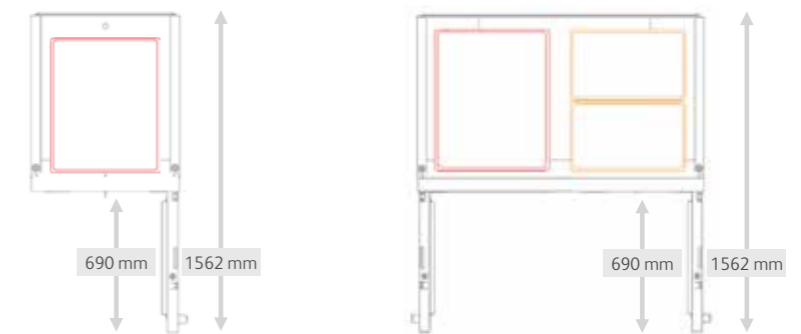

2/1
1/1

SPECIFICATION & OPTIONS

- 2/1 GN Compatible
- Refrigerator or Freezer
- A Energy Rating on 1 door refrigerators
- Refrigerators maintain holding temperatures of 0.5°C to 3.3°C
- C Energy Rating on freezers
- Leg options available
- RCU Reverse Fan Motor
- Freezers maintain holding temperatures of -23°C

Maximise usable space

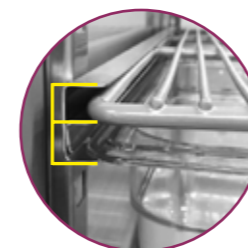

TGN products feature a unique “E” shaped internal slide system designed to accommodate both a wire shelf and a 2/1 GN pan (or 2x 1/1 GN pans) to make full use of the cabinet net capacity.

Smaller pans are not accommodated by the slides but can be placed on the shelves.

Each unit is supplied with 3 pairs of these adjustable slides + 3 shelves.

Pans & trays sold separately.



Refrigerated Equipment Stand TRCB

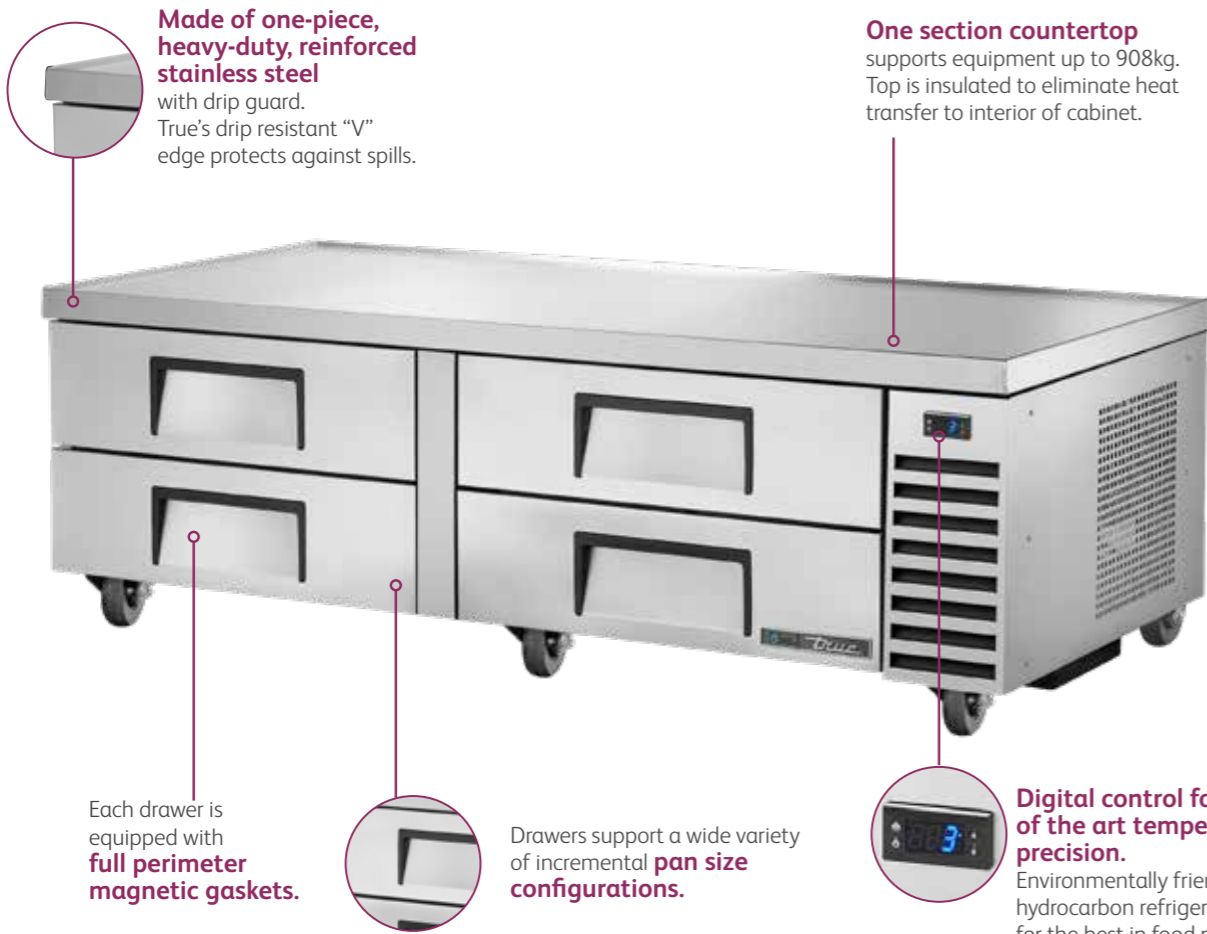

Made of one-piece, heavy-duty, reinforced stainless steel with drip guard. True's drip resistant "V" edge protects against spills.

One section countertop supports equipment up to 908kg. Top is insulated to eliminate heat transfer to interior of cabinet.

Each drawer is equipped with **full perimeter magnetic gaskets.**

Drawers support a wide variety of incremental **pan size configurations.**

Digital control for state of the art temperature precision. Environmentally friendly R290 hydrocarbon refrigeration system for the best in food preservation.



SPECIFICATION & OPTIONS

- 2 to 6 drawer sections
- Wide variety of hot equipment supported
- Refrigerators maintain holding temperatures of 0.5°C to 3.3°C
- Heavy-duty drawer slides and rollers
- All stainless steel front, top and sides

Sections	1	2	2	3	
Product	TRCB-36	TRCB-52	TRCB-72	TRCB-96	TRCB-110
Dimensions LxDxH	924 x 816 x 648	1318 x 816 x 648	1839 x 816 x 648	2426 x 816 x 648	2794 x 775 x 648
Max Support	326 kg	326 kg	492 kg	651 kg	908 kg
# of drawers	2	2	4	4	6
Maximum capacity per drawer	1x 1/1 + 3x 1/6 pans (100mm deep)	3x 1/1 pans (100mm deep)	2x 1/1 pans (100mm deep)	3x 1/1 pans (100mm deep)	2x 1/1 pans (100mm deep)

Depths do not include 26 mm for rear bumpers. More models available upon request.



Note: even though drawer capacity of some TRCB units may appear to accept a larger than 1/1 GN pan, the drawer construction of these units are moulded specifically for this pan size as a way of strengthening the drawer and durability of the product.

GN pans sold separately.



Prep Tables TPP

Supplied as standard with an extra deep (495mm) cutting board.

Forced-air refrigeration system holds 0.5°C to 5°C.



Stainless steel, foam **insulated flat lids.**

Digital control for state of the art temperature precision. Environmentally friendly R290 hydrocarbon refrigeration system for the best in food preservation.



Patented RCU reversing condenser **fan motors.**

Mix door and drawer options.

TPP products are supplied with clear polycarbonate 1/3 GN pans in the unit top area. This space is also configurable, accepting 1/1 pans, or 1/6 pans with the use of divider bars (supplied separately).

SPECIFICATION & OPTIONS

- 1 (1131mm) to 4 (3029mm) sections wide
- Mix door and drawer options
- Accommodates six to fifteen 1/3 GN pans
- 16 different model options
- “Forced air” refrigerated wells maintain consistent 0.5°C to 5°C temperature range in pans and storage
- All stainless “Spec” upgrade available



Sections	1	2	3	4
Product	TPP-AT-44D-2	TPP-AT-67D-4	TPP-AT2-93D-6	TPP-AT-119D-8
Dimensions LxDxH	1133 x 854 x 1133	1709 x 854 x 1133	2369 x 854 x 1133	3029 x 854 x 1133
Top pans	6x 1/3 GN (150mm deep)	9x 1/3 GN (150mm deep)	12x 1/3 GN (150mm deep)	15x 1/3 GN (150mm deep)
# of drawers	2	4	6	8
Maximum capacity per drawer	1x 2/1 GN (200mm deep)	1x 2/1 GN (200mm deep)	1x 2/1 GN (200mm deep)	1x 2/1 GN (200mm deep)

Depths do not include 42 mm cutting board overhang or 26 mm for rear bumpers.

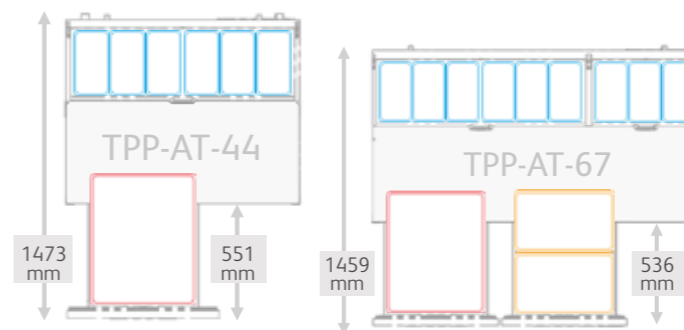

As standard, TPP products are supplied with 1 horizontal divider bar per drawer, facilitating 2x 1/1 pans, 6x 1/3 pans, or a combination of.

To accommodate 1/6 size pans and other combination arrangements, further divider bars will be required.

Top Pans supplied. Drawer pans sold separately.

- 2/1
- 1/1
- 1/3
- 1/6

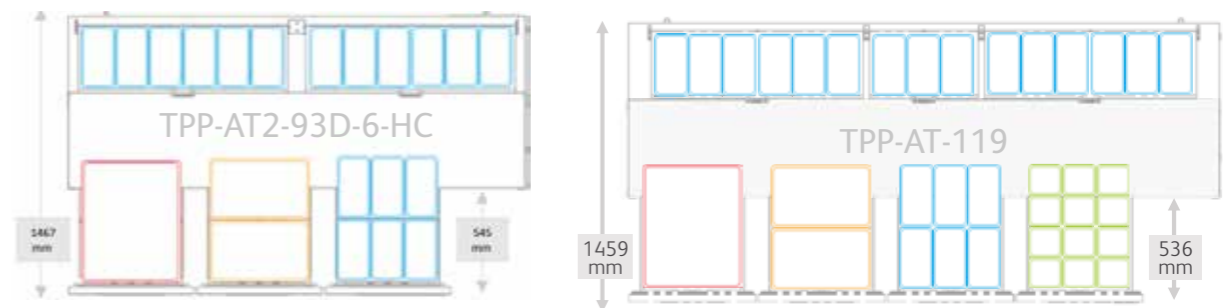

Prep Tables TSSU



TSSU products are supplied with clear polycarbonate 1/6 GN pans in the unit top area, with the relevant divider bars. This space is also configurable, accepting 1/1 pans or 1/3 pans. For different combination layouts, additional divider bars may be required.

SPECIFICATION & OPTIONS

- Model Sizes accommodate eight to thirty 1/6 GN pans
- Mix door and drawer options
- “Mega Top” options feature an additional row of configurable pan space
- “Forced air” refrigerated wells maintain consistent temperature in pans and storage
- Reverse Fan Motor on HC models
- Dual-side models feature cutting board on both sides
- Flat lid options
- Hydraulic glass lid options
- All stainless “Spec” upgrade available



Sections	1	2
Product	TSSU-27-08D-2	TSSU-60-16D-4
Dimensions LxDxH	702 x 766 x 1093	1534 x 766 x 1093
Top pans	8x 1/6 GN (100mm deep)	16x 1/6 GN (100mm deep)
# of drawers	2	4
Maximum capacity per drawer	1x 1/1 GN (150mm deep)	1x 1/1 GN (150mm deep)

Depths do not include 26 mm for rear bumpers.

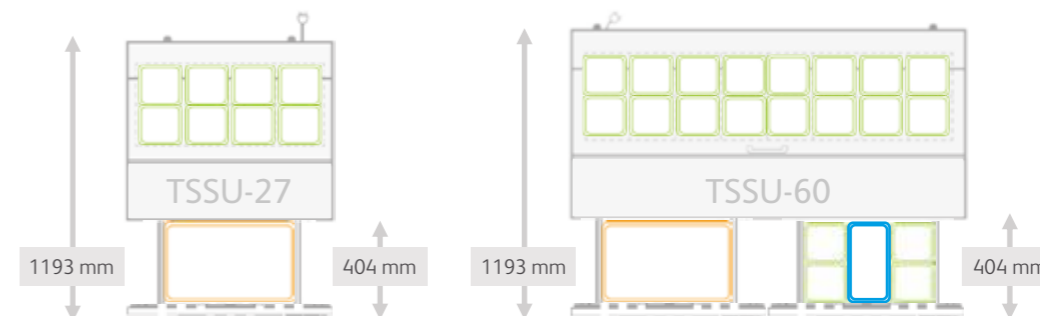

As standard, TSSU products are not supplied with any drawer divider bars. Drawers accommodate 1x1/1 or 3x1/3 pans without the need for additional bars.

Accommodating 6x1/6 requires a single horizontal bar, and mixing with 1/3 pans requires vertical bars.



Prep Tables TSSU

True's TSSU prep tables are available in a wide range of sizes, with 2 or 3 rows of pans.

In addition to the GN drawer products presented on the previous page, we produce a larger range of door models featuring adjustable interior shelving. As standard, TSSU products are supplied with clear polycarbonate 1/6 GN pans in the unit top area, arranged with the relevant divider bars.

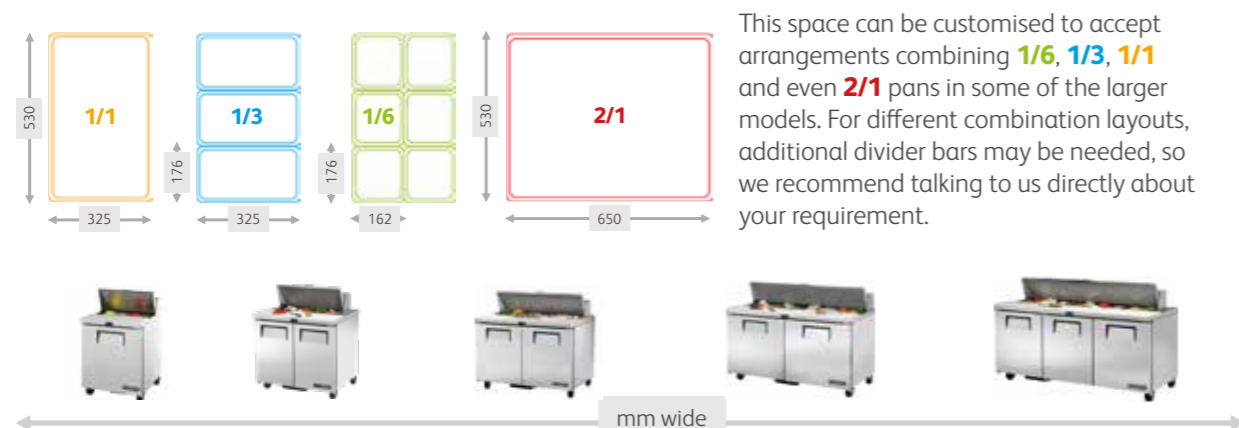

	702	924	1229	1534	1839
mm deep	TSSU-27-08 8x 1/6 GN pans	TSSU-36-08 8x 1/6 GN pans	TSSU-48-12 12x 1/6 GN pans	TSSU-60-16 16x 1/6 GN pans	TSSU-72-18 18x 1/6 GN pans
	TSSU-27-12M-C 12x 1/6 GN pans	TSSU-36-12M-B 12x 1/6 GN pans	TSSU-48-18M-B 18x 1/6 GN pans	TSSU-60-24M-B-ST 24x 1/6 GN pans	TSSU-72-30M-B-ST 30x 1/6 GN pans

150mm maximum pan depth

Visit truerefrigeration.co.uk for more options and sizes from the complete product range

WARRANTY 5 YEARS
PARTS, COMPRESSOR AND LABOUR

Prep Tables TSSU



EMEA

True International GmbH
Messeplatz 10-12
Level 27
4058 Basel
Switzerland
+41 61 563 07 05

UNITED KINGDOM

True Refrigeration
UK Ltd,
Fields End Road,
Rotherham, S.
Yorkshire S63 9EU
+44(0) 800 783 2049

AUSTRALIA

True Refrigeration
Australia P/L,
6b Phiney Place.
Ingleburn,
NSW 2565, Australia
+61 2 9618 9999

TFIUK@truemfg.com

truerefrigeration.co.uk

True
REFRIGERATION